

1.0mm Pitch

SERIES

6208

1.0mmピッチ ZIF ストレート DIP 片面接点 スライドロック

1.0mmPitch ZIF Vertical Through hole Single-sided contact Slide lock

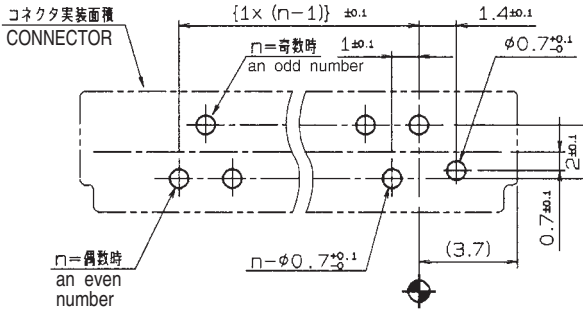
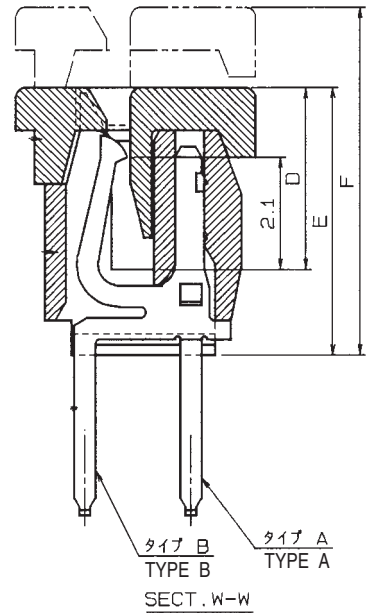
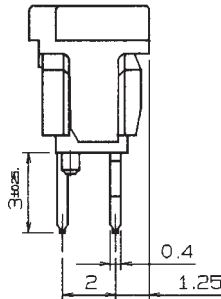
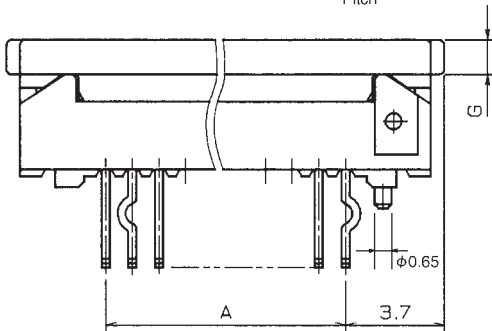
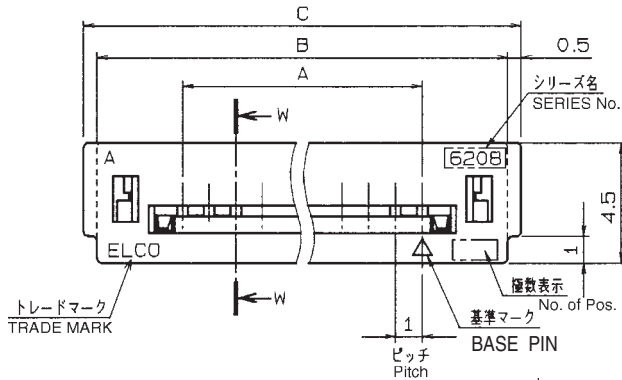

基板取付寸法 (コネクタ搭載側)
MOUNTING LAYOUT
(t=1.2~1.6)

種類 KIND	公差 TOLERANCE		
	P	W	M
FPC	±0.02	±0.05	±0.05
FFC	±0.05	±0.03	±0.1

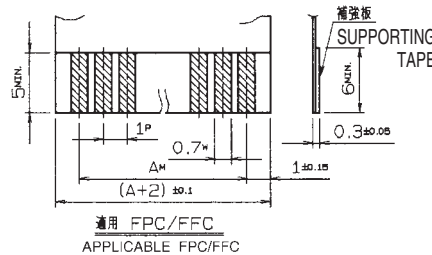

極数 No. of Pos		寸法表 DIMENSION								収納数量 UNITS/TUBE
型番 ASSEMBLY NUMBER		A	B	C	D	E	F	G		
5	0X 6208 XX0 105 XXX X	4.0	10.4	11.4	3.4	5.0	6.5	0.8	42	
6	↑ 106 ↑	5.0	11.4	12.4	↑	↑	↑	↑	38	
7	107	6.0	12.4	13.4	↑	↑	↑	↑	35	
8	108	7.0	13.4	14.4	↑	↑	↑	↑	33	
9	109	8.0	14.4	15.4	↑	↑	↑	↑	31	
10	110	9.0	15.4	16.4	↑	↑	↑	↑	29	
11	111	10.0	16.4	17.4	↑	↑	↑	↑	27	
12	112	11.0	17.4	18.4	↑	↑	↑	↑	26	
13	113	12.0	18.4	19.4	↑	↑	↑	↑	24	
14	114	13.0	19.4	20.4	↑	↑	↑	↑	23	
15	115	14.0	20.4	21.4	↑	↑	↑	↑	22	
16	116	15.0	21.4	22.4	↑	↑	↑	↑	21	
17	117	16.0	22.4	23.4	↑	↑	↑	↑	20	
18	118	17.0	23.4	24.4	↑	↑	↑	↑	19	
19	119	18.0	24.4	25.4	↓	↓	↓	↓	18	
20	120	19.0	25.4	26.4	3.4	5.0	6.5	0.8	18	
21	121	20.0	26.4	27.4	3.6	5.2	6.7	1.0	17	
22	122	21.0	27.4	28.4	↑	↑	↑	↑	17	
23	123	22.0	28.4	29.4	↑	↑	↑	↑	16	
24	124	23.0	29.4	30.4	↑	↑	↑	↑	16	
25	125	24.0	30.4	31.4	3.6	5.2	6.7	1.0	15	
26	126	25.0	31.4	32.4	3.9	5.5	7.0	1.3	15	
27	127	26.0	32.4	33.4	↑	↑	↑	↑	14	
28	128	27.0	33.4	34.4	↑	↑	↑	↑	14	
29	129	28.0	34.4	35.4	↓	↓	↓	↓	13	
30	0X 6208 XX0 130 XXX X	29.0	35.4	36.4	3.9	5.5	7.0	1.3	13	

注文コード ORDERING CODE

XX 6208 XX0 1XX XXX X

08: マガジン TUBE PACKAGE
(ONLY WITHOUT KINKED BOSS)
00: トレー 梱包
TRAY PACKAGE

0: キング有 WITH KINKED
1: キング無 WITHOUT KINKED
0: ボス無 WITHOUT BOSS
1: ボス付 WITH BOSS

極数
NUMBER
OF
POSITIONS

生産対応可能極数については、営業部にご確認願います。

Feel free to contact our sales department for available numbers of positions.

001+: スズ銅めっき Sn-Cu Plated (RoHS対応品 RoHS Compliant Product)

001: スズ鉛めっき Sn-Pb Plated

020+: 金めっき Au Plated (RoHS対応品 RoHS Compliant Product)

1.0mm Pitch

SERIES

6208

1.0mmピッチ ストレート SMT スライドロック
1.0mmPitch Vertical SMT Slide lock

ボス無 WITHOUT BOSS

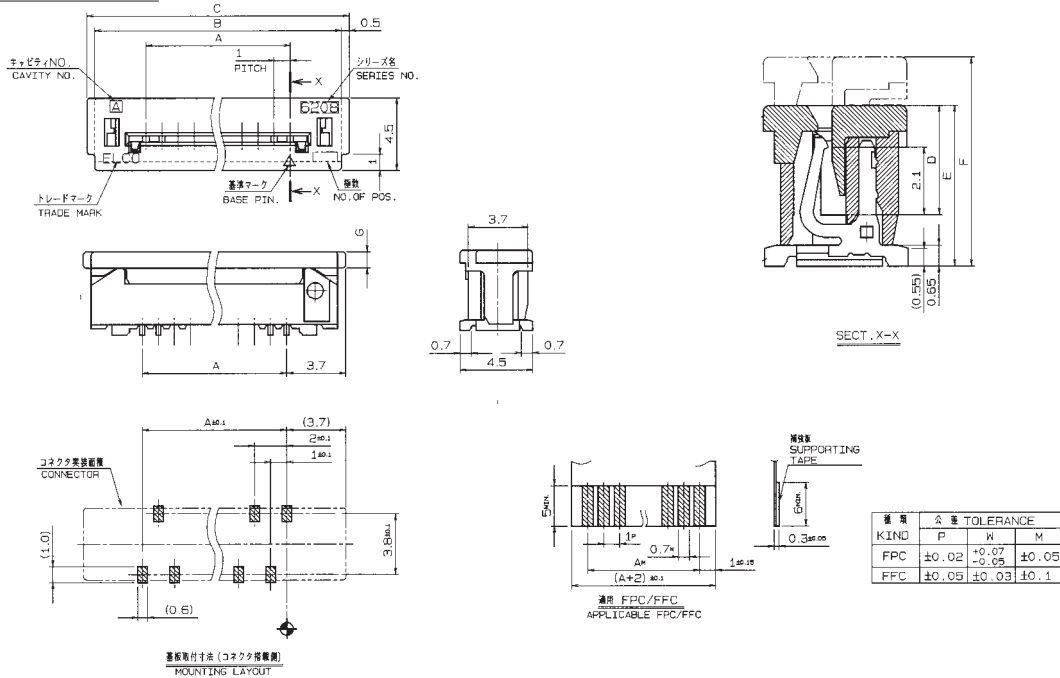

ボス付 WITH BOSS

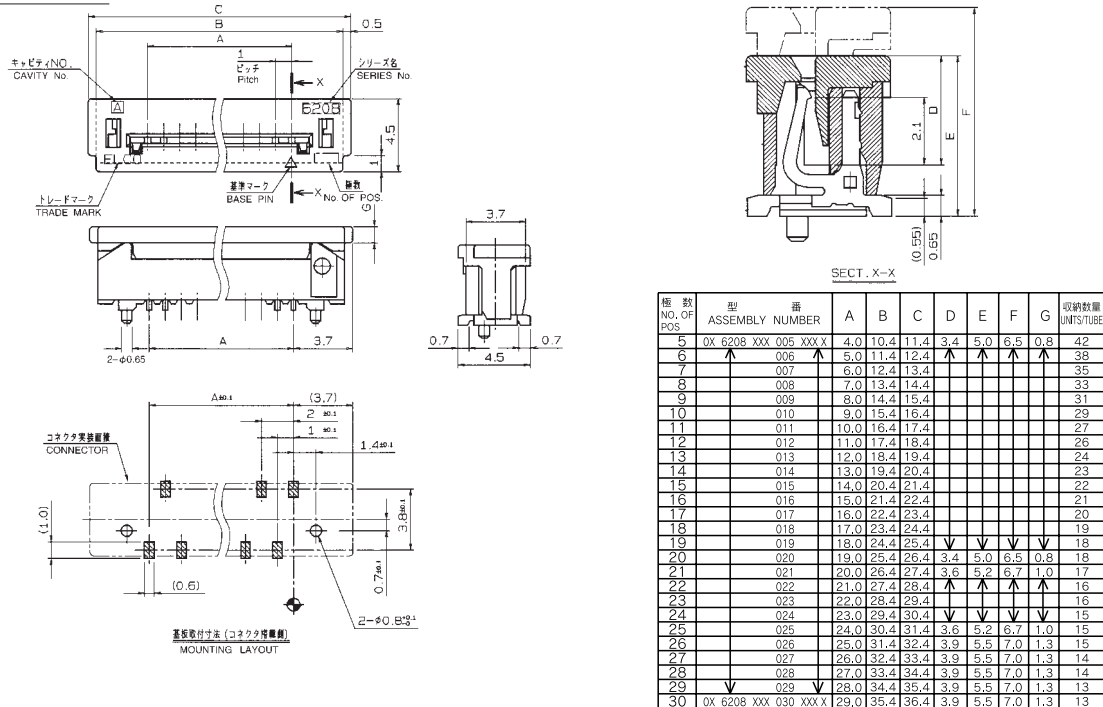

注文コード ORDERING CODE
XX 6208 XXX 0XX XXX X

00 : トレー梱包
TRAY PACKAGE
08 : マガジン
TUBE PACKAGE (ボス無しのみ ONLY WITHOUT BOSS)

バリエーション VARIATION CODE
500 : SMT ボス無 WITHOUT BOSS
520 : SMT ボス付 WITH BOSS

極数
NUMBER
OF
POSITIONS

エンボス梱包品: 00 6208 5XX X10 XXX X
Tape & Reel Package 00 6208 5XX X10 XXX X

000+ : スズ銅めっき Sn-Cu Plated (RoHS対応品 RoHS Compliant Product)
000 : スズ鉛めっき Sn-Pb Plated
009+ : カーボンフレキ対応 C/Ag type (RoHS対応品 RoHS Compliant Product)
009 : カーボンフレキ対応 C/Ag type
852+ : 金めっき Au Plated (RoHS対応品 RoHS Compliant Product)
852 : 金めっき Au Plated

生産対応可能極数については、営業部にご確認願います。
Feel free to contact our sales department for available numbers of positions.

1.0mm Pitch

SERIES

6208

エンボス梱包品 SMT
Tape and Reel Package SMT

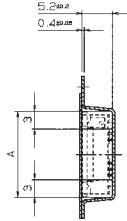
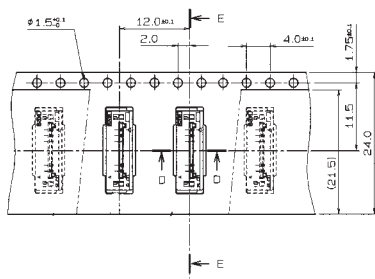

SECT. E-E

型番 ASSEMBLY NUMBER	極数 NO.OF POS.	A
00 6208 505 110 XXX X	5	11.6
↑ 506 ↑	6	12.6
507	7	13.6
508	8	14.6
↓ 509 ↓	9	15.6
00 6208 510 110 XXX X	10	16.6

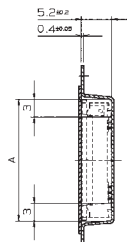
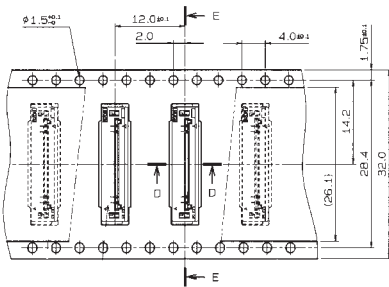

SECT. E-E

型番 ASSEMBLY NUMBER	極数 NO.OF POS.	A
00 6208 511 210 XXX X	11	17.6
↑ 512 ↑	12	18.6
513	13	19.6
514	14	20.6
↓ 515 ↓	15	21.6
00 6208 516 210 XXX X	16	22.6

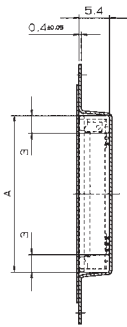
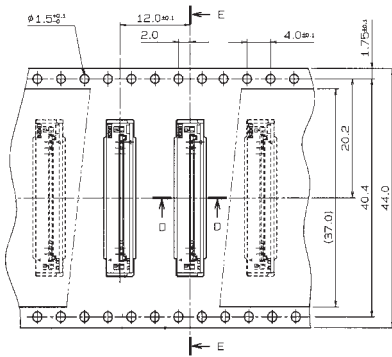

SECT. E-E

型番 ASSEMBLY NUMBER	極数 NO.OF POS.	A
00 6208 517 310 XXX X	17	23.6
↑ 518 ↑	18	24.6
519	19	25.6
520	20	26.6
521	21	27.6
522	22	28.6
523	23	29.6
524	24	30.6
↓ 525 ↓	25	31.6
00 6208 526 310 XXX X	26	32.6

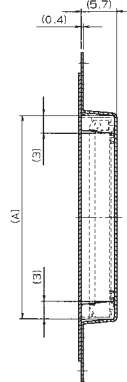
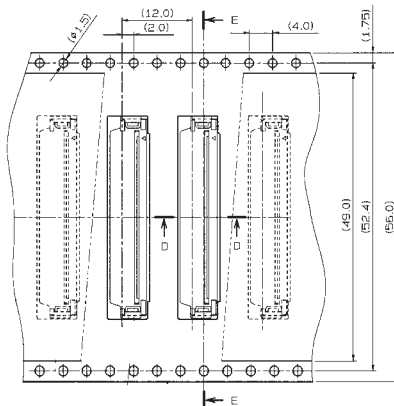

SECT. E-E

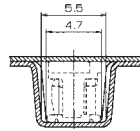

SECT. D-D

型番 ASSEMBLY NUMBER	極数 NO.OF POS.	A
00 6208 527 410 XXX X	27	33.6
↑ 528 ↑	28	34.6
↓ 529 ↓	29	35.6
00 6208 530 410 XXX X	30	36.6

生産対応可能極数については、営業部にご確認願います。
Feel free to contact our sales department for available numbers of positions.

注文コード ORDERING CODE

00 6208 5XX X10 XXX X

極数
NUMBER
OF
POSITIONS

バリエーション VARIATION CODE
1 : エンボス Tape & Reel 24.0mm
2 : エンボス Tape & Reel 32.0mm
3 : エンボス Tape & Reel 44.0mm
4 : エンボス Tape & Reel 56.0mm

000+ : スズ銅めっき Sn-Cu Plated (RoHS対応品 RoHS Compliant Product)
000 : スズ鉛めっき Sn-Pb Plated
009+ : カーボンフレキ対応 C/Ag type (RoHS対応品 RoHS Compliant Product)
009 : カーボンフレキ対応 C/Ag type
008+ : 金めっき Au Plated (RoHS対応品 RoHS Compliant Product)
008 : 金めっき Au Plated

梱包数量 1000個/リール
PACKING QUANTITY : 1000/Reel